



www.esaunggul.ac.id

CMC 101 TOPIK DALAM PEMROGRAMAN
PERTEMUAN 14-a
PROGRAM STUDI MAGISTER ILMU KOMPUTER
FAKULTAS ILMU KOMPUTER

TOPIK DALAM PEMROGRAMAN

Struktur Data Dasar

Pertemuan 9

TUJUAN PERKULIAHAN

- Mahasiswa memahami beberapa tipe persoalan yang penting, dan beberapa jenis struktur data utama

Definition

- Data structure is representation of the logical relationship existing between individual elements of data.
- In other words, a data structure is a way of organizing all data items that considers not only the elements stored but also their relationship to each other.

Introduction

- Data structure affects the design of both structural & functional aspects of a program.

Program=algorithm + Data Structure

- You know that a algorithm is a step by step procedure to solve a particular function.

Introduction

- That means, algorithm is a set of instruction written to carry out certain tasks & the data structure is the way of organizing the data with their logical relationship retained.
- To develop a program of an algorithm, we should select an appropriate data structure for that algorithm.
- Therefore algorithm and its associated data structures from a program.

Classification of Data Structure

- Data structure are normally divided into two broad categories:
 - Primitive Data Structure
 - Non-Primitive Data Structure

Classification of Data Structure

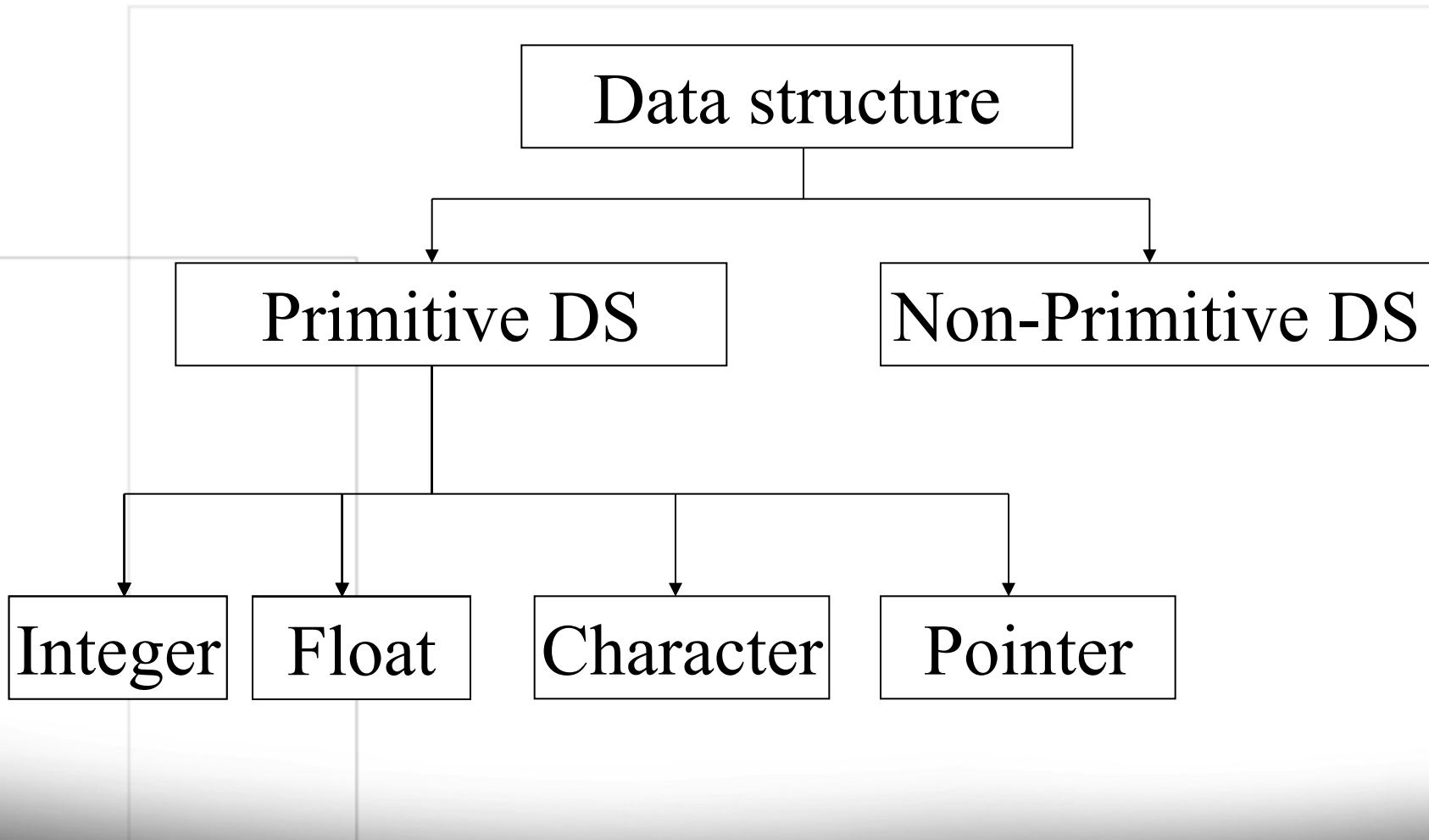

Classification of Data Structure

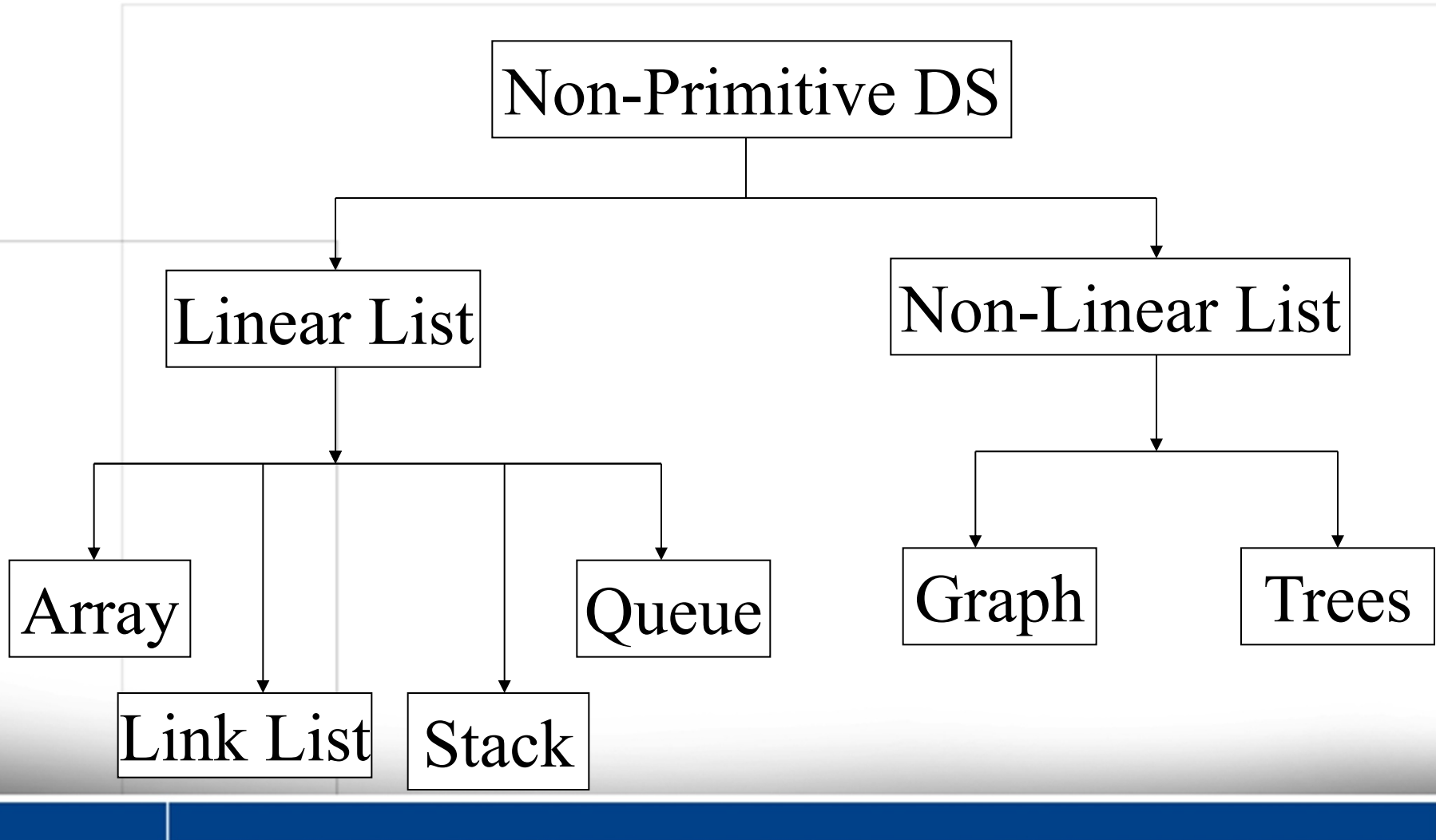

Primitive Data Structure

- There are basic structures and directly operated upon by the machine instructions.
- In general, there are different representation on different computers.
- Integer, Floating-point number, Character constants, string constants, pointers etc, fall in this category.

Non-Primitive Data Structure

- There are more sophisticated data structures.
- These are derived from the primitive data structures.
- The non-primitive data structures emphasize on structuring of a group of homogeneous (same type) or heterogeneous (different type) data items.

Non-Primitive Data Structure

- Lists, Stack, Queue, Tree, Graph are example of non-primitive data structures.
- The design of an efficient data structure must take operations to be performed on the data structure.

Non-Primitive Data Structure

- The most commonly used operation on data structure are broadly categorized into following types:
 - Create
 - Selection
 - Updating
 - Searching
 - Sorting
 - Merging
 - Destroy or Delete

Different between them

- A primitive data structure is generally a basic structure that is usually built into the language, such as an integer, a float.
- A non-primitive data structure is built out of primitive data structures linked together in meaningful ways, such as a or a linked-list, binary search tree, AVL Tree, graph etc.

Description of various Data Structures : Arrays

- An array is defined as a set of finite number of homogeneous elements or same data items.
- It means an array can contain one type of data only, either all integer, all float-point number or all character.

Arrays

- Simply, declaration of array is as follows:

```
int arr[10]
```
- Where int specifies the data type or type of elements arrays stores.
- “arr” is the name of array & the number specified inside the square brackets is the number of elements an array can store, this is also called sized or length of array.

Arrays

- Following are some of the concepts to be remembered about arrays:
 - The individual element of an array can be accessed by specifying name of the array, following by index or subscript inside square brackets.
 - The first element of the array has index zero[0]. It means the first element and last element will be specified as:arr[0] & arr[9] Respectively.

Arrays

- The elements of array will always be stored in the consecutive (continues) memory location.
- The number of elements that can be stored in an array, that is the size of array or its length is given by the following equation:
$$(\text{Upperbound}-\text{lowerbound})+1$$

Arrays

- For the above array it would be $(9-0)+1=10$, where 0 is the lower bound of array and 9 is the upper bound of array.
- Array can always be read or written through loop. If we read a one-dimensional array it require one loop for reading and other for writing the array.

Arrays

– For example: Reading an array

```
For(i=0;i<=9;i++)  
    scanf("%d",&arr[i]);
```

– For example: Writing an array

```
For(i=0;i<=9;i++)  
    printf("%d",arr[i]);
```

Arrays

- If we are reading or writing two-dimensional array it would require two loops. And similarly the array of a N dimension would required N loops.
- Some common operation performed on array are:
 - Creation of an array
 - Traversing an array

Arrays

- Insertion of new element
- Deletion of required element
- Modification of an element
- Merging of arrays

Lists

- A lists (Linear linked list) can be defined as a collection of variable number of data items.
- Lists are the most commonly used non-primitive data structures.
- An element of list must contain at least two fields, one for storing data or information and other for storing address of next element.
- As you know for storing address we have a special data structure of list the address must be pointer type.

Lists

- Technically each such element is referred to as a node, therefore a list can be defined as a collection of nodes as show bellow:

[Linear Liked List]

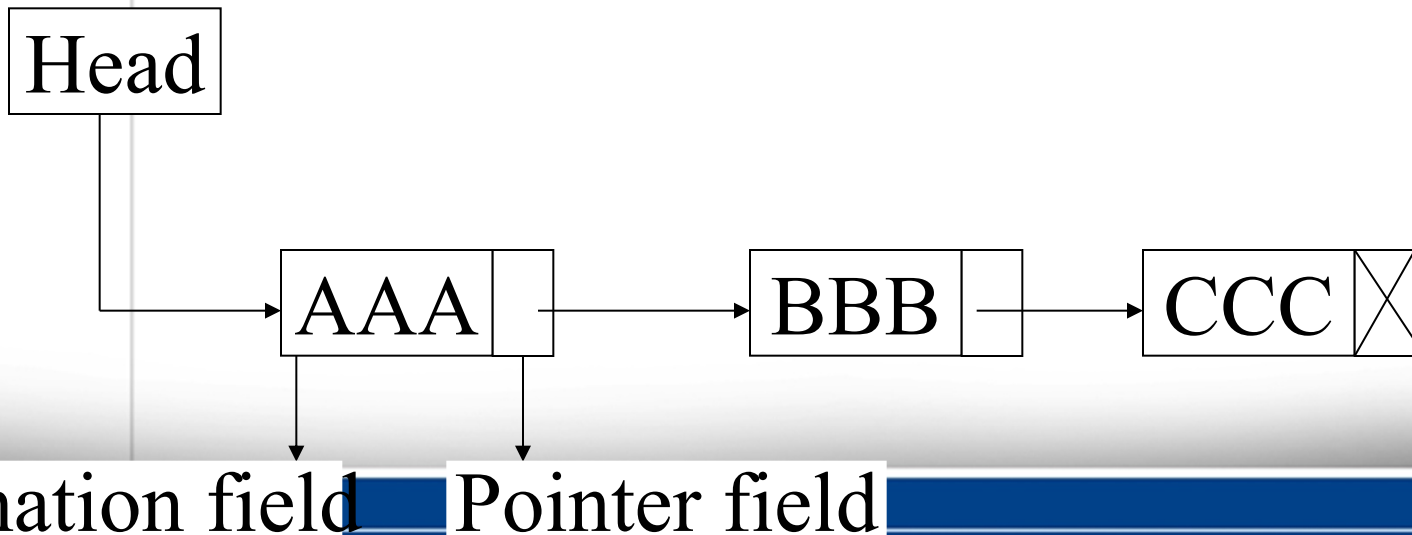

Lists

- Types of linked lists:
 - Single linked list
 - Doubly linked list
 - Single circular linked list
 - Doubly circular linked list

Stack

- A stack is also an ordered collection of elements like arrays, but it has a special feature that deletion and insertion of elements can be done only from one end called the top of the stack (TOP)
- Due to this property it is also called as last in first out type of data structure (LIFO).

Stack

- It could be through of just like a stack of plates placed on table in a party, a guest always takes off a fresh plate from the top and the new plates are placed on to the stack at the top.
- It is a non-primitive data structure.
- When an element is inserted into a stack or removed from the stack, its base remains fixed where the top of stack changes.

Stack

- Insertion of element into stack is called PUSH and deletion of element from stack is called POP.
- The bellow show figure how the operations take place on a stack:

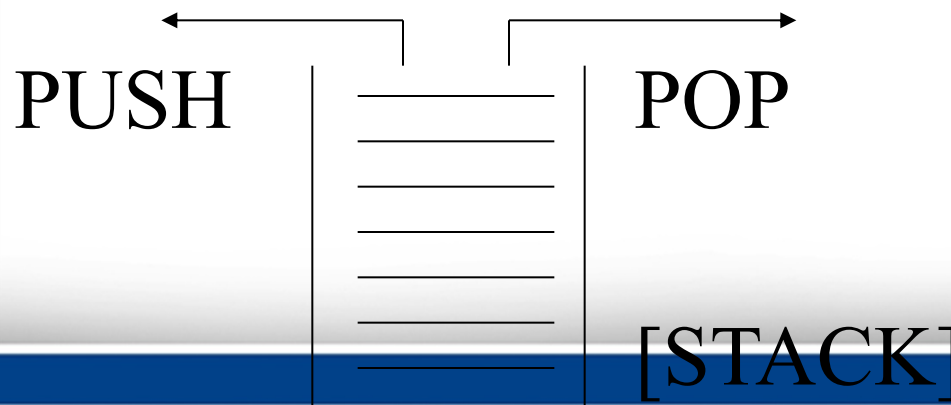

Stack

- The stack can be implemented into two ways:
 - Using arrays (Static implementation)
 - Using pointer (Dynamic implementation)

Queue

- Queue are first in first out type of data structure (i.e. FIFO)
- In a queue new elements are added to the queue from one end called REAR end and the element are always removed from other end called the FRONT end.
- The people standing in a railway reservation row are an example of queue.

Queue

- Each new person comes and stands at the end of the row and person getting their reservation confirmed get out of the row from the front end.
- The bellow show figure how the operations take place on a stack:

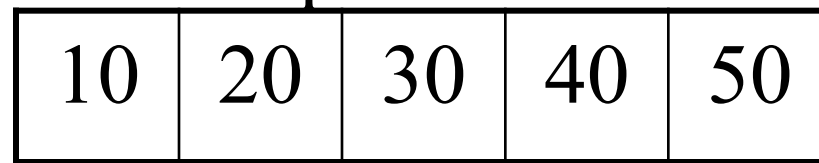

front

rear

Queue

- The queue can be implemented into two ways:
 - Using arrays (Static implementation)
 - Using pointer (Dynamic implementation)

Trees

- A tree can be defined as finite set of data items (nodes).
- Tree is non-linear type of data structure in which data items are arranged or stored in a sorted sequence.
- Tree represent the hierarchical relationship between various elements.

Trees

- In trees:
- There is a special data item at the top of hierarchy called the Root of the tree.
- The remaining data items are partitioned into number of mutually exclusive subset, each of which is itself, a tree which is called the sub tree.
- The tree always grows in length towards bottom in data structures, unlike natural trees which grows upwards.

Trees

- The tree structure organizes the data into branches, which related the information.

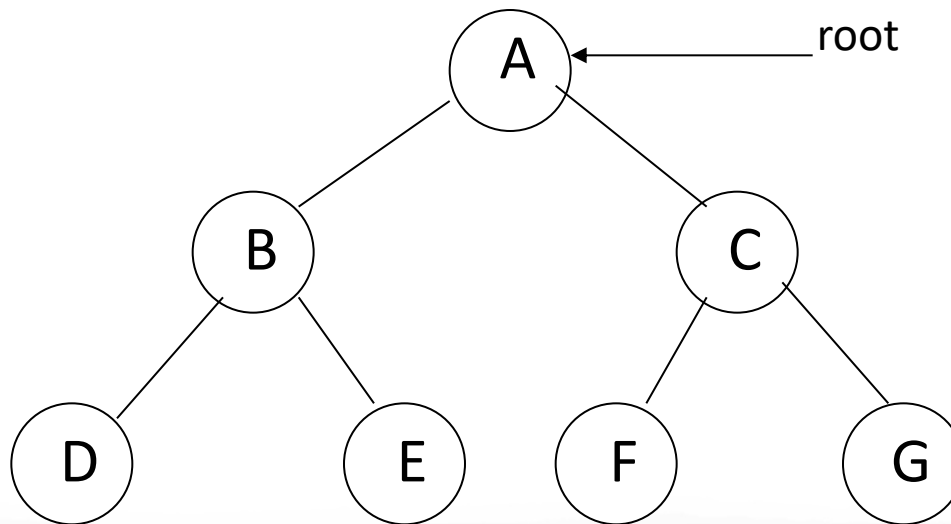

Graph

- Graph is a mathematical non-linear data structure capable of representing many kind of physical structures.
- It has found application in Geography, Chemistry and Engineering sciences.
- Definition: A graph $G(V,E)$ is a set of vertices V and a set of edges E .

Graph

- An edge connects a pair of vertices and many have weight such as length, cost and another measuring instrument for according the graph.
- Vertices on the graph are shown as point or circles and edges are drawn as arcs or line segment.

Graph

- Example of graph:

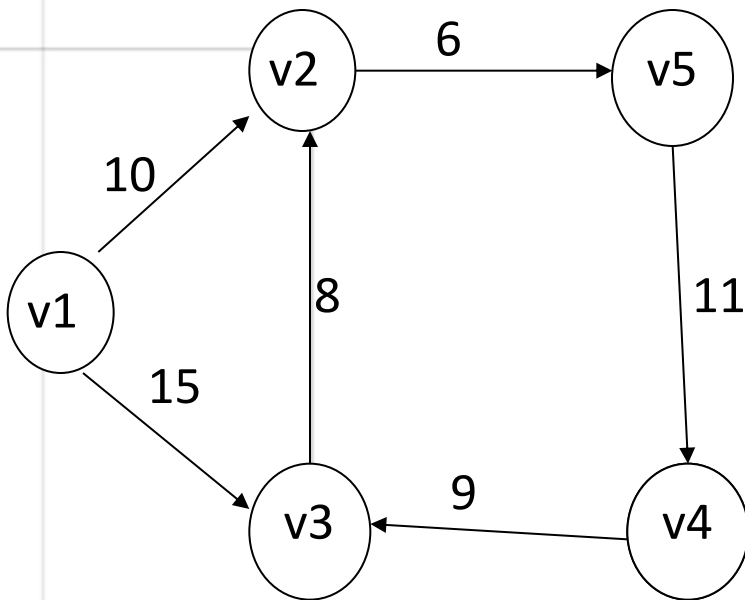

[a] Directed & Weighted Graph

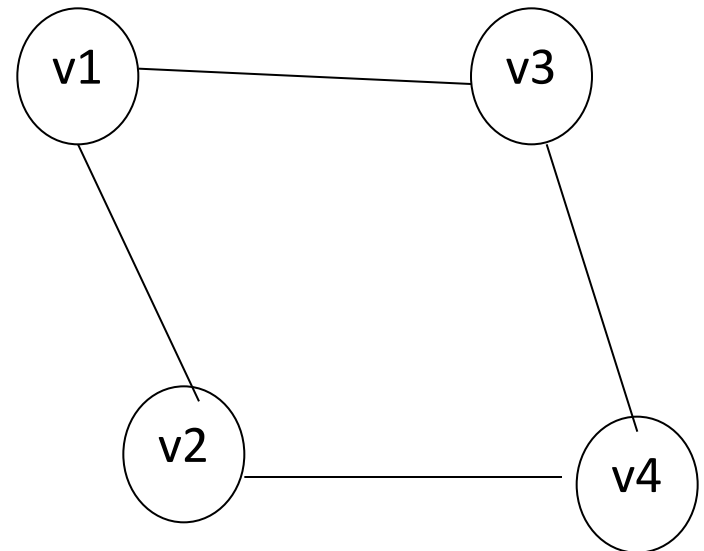

[b] Undirected Graph

Graph

- Types of Graphs:
 - Directed graph
 - Undirected graph
 - Simple graph
 - Weighted graph
 - Connected graph
 - Non-connected graph